

# FOXWOOD BARN

Homeowner's Guide



*Love where  
you live*



**Glenveagh**  
Home of the new.



**LOVE  
NEW BEGINNINGS  
LIVE  
FOR LASTING  
MEMORIES**

## CEO STATEMENT

Dear **Homeowner**,

Glenveagh Properties is delighted to welcome you to your new community, Foxwood Barn. We sincerely hope that your home opens up brand new hopes, dreams and possibilities.

At Glenveagh, we are dedicated to providing affordable housing solutions that combine sleekness and convenience in perfect measure. From functional interiors to state-of-the-art appliances, we promise that your new Glenveagh home will meet all your needs.

We aspire to create community engagement opportunities across all of our housing developments. Our goal is to positively impact our local residents, whilst being involved in projects that are scalable, practical, and progressive.

In line with this, we seek to identify social barriers in modern developments and create opportunities for residents to become active citizens within them.

By bringing people together, promoting sustainability, encouraging innovation, and facilitating resident health and well-being, we guarantee to cement not only solid houses but also thriving communities.

Your comfort and satisfaction lie at the very heart of our projects.

If you have any queries or concerns, feel free to get in touch with us via email: [customercare@glenveagh.ie](mailto:customercare@glenveagh.ie).

We hope your dream life awaits.

Sincerely,



**Stephen Garvey**

*Love where  
you live*



# LOVE COMMUNITY WELCOMES

LOVE  
A PLACE OF  
YOUR OWN  
LIVE  
FOR  
SHAPING IT

## Table of Contents

Customer Care	7
Your Warranty	8
Homebond Scheme	12
Homebond Scheme Latent Defects Insurance Policy	13
<b>Systems &amp; Equipment</b>	
Heating & Hot Water System Overview	17
A Guide to Condensation	18
Heating Controls	19
Water Systems	20
Mechanical & Ventilation Systems	21
Mechanical & Ventilation Systems FAQ	23
Systems & Equipment EPS Water Tank O&M	24
Electrical Systems	27
Electrical Installation	30
Lighting Control	32
<b>Kitchen Overview</b>	
Solid Surface Countertop Warranty Information	35
Laminate Countertop Warranty	37
Extractor Fans & Hobs	39
Cabinetry Warranty Information	40
<b>Maintenance &amp; Care Guide</b>	
Windows & Doors	43
External Condensation	46
Internal Condensation	47
Lawncare	48
Tree Care	51
Sustainability	52
<b>Know your area</b>	
Location	55
Transport	56
Amenities	57
Education	58
Healthcare	60
Essentials	62
Social	64
Live for Being Active	65
Our Community	66



# CUSTOMER CARE

**Settling into a new home is an exciting time for new homeowners – but it can be a little overwhelming as well.**

That's why we have our own dedicated Customer Care team on hand to help with any issues within your home or any general queries, ensuring that you have a pleasant and positive experience while living in Foxwood Barn.

We want to ensure that all our customers are well looked after and in safe hands. And that's why we are always available for them when they need it.

## **Our team is made up of:**



**Anne-Marie McGill**  
**Senior Customer Care Manager**

In charge of our customer care department is Anne-Marie, who is dedicated to looking after our customers across all our sites throughout the country. With her expertise, you can be sure that your experience living in a Glenveagh development will be positive.



**Chloe Pearson**  
**Graduate Customer Care Coordinator**

Chloe is always available to answer any questions to ensure that you have an easy and stress-free move.



**Tara Bohan**  
**Customer Care Coordinator**

Tara is always ready to lend a hand to those who need assistance with their new homes. No matter what your queries may be, feel free to get in touch.

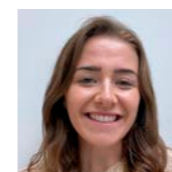

**Madeline Ronayne**  
**Customer Care Coordinator**

If you need assistance with your Glenveagh property, Madeline is here to answer any queries before, during and after your move.



**Kayleigh Purfield**  
**Customer Care Coordinator**

For all new home-related queries, do not hesitate to reach out to Kayleigh who is always happy to help.



**Siona Curtis**  
**Customer Care Coordinator**

For all new home-related queries, do not hesitate to reach out to Siona who is always happy to help.

For any general assistance, please feel free to get in touch with us via email: [customercare@glenveagh.ie](mailto:customercare@glenveagh.ie)

# YOUR WARRANTY

## Understanding major and minor warranties

At Glenveagh, your convenience is our top priority! We make it a point to help you before, during, and after your move to ensure that all your needs are met. That's why we provide your new home with various warranties, ranging from 6 to 18 months. Following this period, we will be more than happy to assist in finding a contractor with a small call-out fee.

Under your Contract with Glenveagh for the purchase of your home, Glenveagh agrees to make good any major defects which arise in your home for a period of 18 months from the date that we notify your solicitor that the works to your home have been completed and to make good on any minor defects which arise within a period of 6 months from the same date.

### The following do not constitute either major or minor defects:

- Cracks in plaster work;
- Defects or damage in paintwork or decoration;
- Normal shrinkage or expansion of timber;
- Defects in plasterwork or damage occurring in your home by reason of the normal operation of the central heating system;
- Damage or defects caused by negligence or abuse by you;
- Damage or defects caused by fair wear and tear;
- Items covered by a separate guarantee issued to you by the manufacturers (please see more details below).

Glenveagh will also not be liable for any damage caused by adverse weather conditions, negligence, abuse or maintenance of your garden, home or its appliances.

Glenveagh's obligations under the contract may also be affected if you decide to make any alterations or extensions to the property on a structural level. It may also be your responsibility to register the warranties for your appliances with the manufacturer and you should check your warranty documents carefully to ensure that you do what is required in this situation.

### DISCLAIMER

The material in this guide is sourced largely from our suppliers and manufacturers and is provided for information purposes only. Glenveagh Homes Limited believes that the information is accurate and reliable. However, Glenveagh Homes Limited makes no representations or warranties, expressed or implied, regarding the information, products and/or processes described herein and/or as to the accuracy or completeness of such information. Glenveagh Homes Limited disclaims all or any liability for the use of such information and shall not be liable for any damages, losses, costs or expenses, direct, indirect or incidental, consequential or special, arising out of, or related to the use of the information in this material or the products or processes described herein.

This manual sets out various instances where suppliers and/or manufacturers have provided guarantees and/or warranties in respect of products and/or services supplied by them. Glenveagh Customer Care will assist you with any issue in relation to such guarantees or warranties for a period of eighteen months from the date that we notify you that the works to your home have been completed. Thereafter, we will be glad to assist in arranging a contractor, where applicable.

## Major & Minor Defects During Warranty

Type	Description	Defect Type	Time period	Contact
<b>External</b>				
<b>Cracking</b>	• Concrete crack more than 5mm in diameter	Major	18 Months	Glenveagh
<b>Landscape</b>	• Hard landscaping: Drainage systems, curtilage, paving			
<b>Building envelope</b>	• Front door hardware and ironmongery. • Windows: difficult to lock, warped and/or need adjusting to be able to close, scratch marks.			
<b>Building envelope</b>	• Roofing issues: • Tiles, ridges, fascia, soffit	Minor	6 Months	
<b>Cracking</b>	• Concrete cracks less than 5mm in diameter			
<b>Landscape</b>	• Fencing: loose panels or posts. • Garden drainage.			
<b>Internal</b>				
<b>Mechanical</b>	• Blockages/drainage. • Pipework leaks. • Central heating-failure/malfunction. • Hot water issues • Cold water tank issues	Major	18 Months	Glenveagh
<b>Condensation</b>	• Forming between panes of glass			
<b>Kitchen</b>	• Extractor fan not working • Appliance failure (if supplied by Glenveagh)	Major	18 Months	
<b>Electrical</b>	• Heat or smoke detector issues. • Circuit breaker issues.			
<b>Mechanical</b>	• Sealant around shower/bath area. • Sanitaryware Part of customer maintenance every 18-24 months			
<b>Flooring and wall coverings</b>	• Tiling & Grouting • Sub-floor	Minor	6 Months	Glenveagh
<b>Carpentry</b>	• Internal door: Adjustment needed/difficult to be locked/door handles			
<b>Kitchen</b>	• Kitchen unit • door alignment • Seal around countertop			



## Customer Responsibility

Location	Type	Description	Defect Type
<b>External</b>			
<b>Soft Landscaping</b>		Front and back gardens, pruning and hedging	Maintenance
<b>Internal</b>			
<b>Soft Landscaping</b>		Front and back gardens, pruning and hedging	Maintenance
<b>Plumbing</b>		If an aerator is blocked customer needs to ensure it is cleaned or replaced	Maintenance
		Blockages - if caused by materials, debris or rubbish not caused by Glenveagh	Maintenance
<b>Cracking</b>		Hair cracks in plaster work;	Maintenance
		Defects or damage in paintwork or decoration;	Maintenance
		Defects or damage in paintwork or decoration;	Maintenance
		Defects in plasterwork or damage occurring in the Works because of the operation of any central heating system;	Maintenance
		Damage or defects caused by negligence or abuse on the part of the Employer, his servants, agents, licensees or invitees	Maintenance
		Damage or defects caused by fair wear and tear	Maintenance
<b>Building Envelope</b>		Guttering & Downpipes – Cleaning of gutters and downpipes	Maintenance

If a mechanical component or product is replaced during warranty, ie pump then there will be a new warranty from the date it is changed over. Any damage to radiators or trvs falls under 6 month warranty.

# WARRANTY FAQ

### What is an emergency?

When there is a complete loss of your water supply in the home prior to checking the water supply status in the locality.

When a water leak cannot be contained and is causing damage to the house.

Loss of power supply – in which case the ESB Networks should be contacted before Glenveagh.

Heating not working - before contacting Glenveagh, please ensure that all switches are on including slats.

### Who gets contacted in a non-emergency?

For all non-emergencies please contact our Customer Care email at [customercare@glenveagh.ie](mailto:customercare@glenveagh.ie) during Glenveagh office hours (08:00-17:00) where they will be responded to and acknowledged within 72 working hours.

Examples of non-emergencies include dripping taps, blocked drains, faulty kitchen appliances, air in radiators, noise from heating system or water pumps, operational issues with heat pump, perceived issues with temperature in the house, condensation on windows, and operation of overflows or safety valve from water tank or cylinder.



# HOMEBOND LATENT DEFECTS INSURANCE POLICY

## Insurance Product Information Document

This Policy is arranged by Ark Insurance Group Ltd. in conjunction with the Scheme Administrator Global Home Warranties Ltd. of Unit 3C Fingal Bay Business Park, Harry Reynolds Road, Balbriggan, Co Dublin.

Global Home Warranties Ltd. are an Appointed Representation of Peacock Insurance Services Ltd., who are authorised and regulated by the Financial Conduct Authority and have been granted the right to trade in the Republic of Ireland by the Central Bank of Ireland.

Ark Insurance Group Ltd. is authorised and regulated by the Financial Conduct Authority and entered on the FCA register under number 706598 and has been granted the right to trade in the Republic of Ireland by the Central Bank of Ireland.

The Insurer is International General Insurance Company (UK) Ltd. and is registered in England and Wales (registration no.06870207), authorised by the Prudential Regulation Authority and regulated by the Financial Conduct Authority, Central Bank of Ireland and Prudential Regulation Authority for the conduct of UK and ROI business.

## What is this type of insurance?

HomeBond provides cover for 1) loss of deposit and damage caused by defects and structural defects in newly built houses and 2) damage or impending damage to insured equipment caused by defects.

## What is insured?

**Defects Insurance (1.2):** Covers the cost of rectifying damage to your property caused by a structural defect and resulting in Water/Smoke Ingress; Physical danger which could cause death or physical harm to occupants; Damage caused by certain defects affecting a significant portion of the habitable domestic areas.

**Structural Insurance (1.3):** Covers the cost of repairing major damage caused by a defect in the original construction.

**Extra Cover:** Where a claim is paid we may also pay:

- Reasonable costs to comply with Building Regulations
- Alternative accommodation costs whilst the property is uninhabitable
- Professional fees relating to the repair or rebuilding work
- Reasonable debris removal and demolition expenses
- Temporary and fast-track repair costs
- Access and break out costs for equipment
- Reasonable costs of investigating possible repair, replacement or restoration of your equipment.

This document outlines the main benefits and restrictions to cover for the HomeBond Latent Defects Insurance policy. This is not a Policy Document and does not reference all of the benefits, terms, conditions, limitations, exceptions and exclusions associated with your policy. Complete pre-contractual and contractual information on the product is provided in the full policy documentation. Please read your Policy Document in full to ensure that you fully understand the cover provided by your policy. If cover has been restricted on your policy it will be noted on your Certificate of Insurance.

## HOMEBOND SCHEME

### Understanding the HomeBond Guarantee Scheme and how it protects your home against major defects.

Your home has the benefit of cover under the HomeBond Guarantee Scheme. This is a 10-year warranty/insurance policy against major structural defects. The policy details and certificates have been forwarded to your solicitor as part of the conveyancing process.



### What is not insured?

The below list outlines some key areas and items not included in the cover. A full list of exclusions is available in the policy wording.

- Defects or damage known to you prior to purchase of the property
- Damage resulting from alterations undertaken without our consent
- Damage arising from improper use or application of tools during normal maintenance servicing or repair
- Loss or damage caused by Specified Perils (for example fire, lightning or flood) or accidental damage.

### Are there any restrictions on cover?

**Defects Insurance (1.2):** The maximum amount payable is €75,000.

**Structural Insurance (1.3):** The maximum amount payable is €300,000.

In respect of 1.2, 1.3 & 1.4 above if the property is part of a Continuous Structure and the total claims exceed the lesser of the Continuous Structure Limit or the Overall Financial Limit, your claim will be proportionately reduced.

### Where am I covered?

Cover is provided at the address only that is stated on the Certificate of Insurance.

### When and how do I pay?

Payment should be made in accordance with the contractual agreement to purchase the House.

### What are my obligations?

It is the Policyholder's responsibility to ensure a thorough independent inspection is undertaken of the housing unit before hand-over. If the inspection identifies any defects, damage or danger, they should be reported to the developer and rectified before completing the purchase.

- The policyholder should keep a copy of all reports and correspondence with the Developer for their records and produce to HomeBond upon request in the event of a claim under this Policy.

### When does the cover start & end?

Cover for Defects and Equipment Insurance commences on the effective date stated on the Certificate of Insurance (Final Certification) and ceases five (5) years after that date.

Cover for Structural Insurance commences on the effective date stated on the Certificate of Insurance (Final Certification) and ceases ten (10) years after that date.

### How do I cancel the contract?

Your rights to cancel your policy cooling-off period: You have 14 working days to make sure that You are happy with the cover provided. You can cancel the policy by telling Us in writing and returning the Certificate of Insurance. This 14 working day period, known as the 'cooling-off period', starts on:

- the day you receive your policy following the inception of the cover; or
- the date the period of insurance starts; whichever is later. You may not cancel the policy at any other time.

**If you do cancel the policy within the cooling-off period, as long as You have not made a claim, we will refund to the Developer of Your property any premiums that they have paid.**

**If You have made a claim, the developer of Your property will not get a refund.**



# SYSTEMS & EQUIPMENT

Use and maintain your new home's mechanical equipment.



## SYSTEMS & EQUIPMENT

# HEATING & HOT WATER SYSTEM OVERVIEW

**The dwelling is provided with a high-efficiency air-to-water heat pump which provides heating and hot water. There are detailed instructions and more information on how this pump operates available in the operational manual supplied. The external heat pump unit is located at the rear of the dwelling.**

The heating system is designed to provide the homeowner with two separate heating zones. The ground floor area is Zone 1 and is controlled by the thermostat located in the ground floor Hallway. The first floor is Zone 2 and is controlled by the thermostat at the upper-level landing area. The homeowner can set the thermostat to the required temperature by turning the dial on the thermostat. The maximum temperature setting for the heating system is 21 degrees.

Heat pumps operate differently from standard gas boiler installations, in that the heating water temperature is significantly lower. The lower the heating water temperature through the radiators, the more efficient and cheaper the system will be.

Homeowners should be advised that in order to operate at its most efficient, the system should not be turned off. The zone thermostats will control the heat pump and reduce output when heating demand is satisfied. In this way, the heat pump can ensure a comfortable environment is achieved, with the benefit of lower energy costs. Turning the heat pump on and off like a boiler system results in periods of high loading and this will reduce the efficiency and increase running costs.

When the heating system is operational and the set temperature is reached within the zone, the system will close the valve serving the heating zone until the temperature in the zone drops below the set temperature.

In addition to the heating thermostats, individual radiators are provided with thermostatic mixing valves. These can be adjusted independently of the zone thermostat, allowing an increase or decrease of radiator output as required in each room. This will not override zone thermostat settings so will only allow lower temperatures in zones where this is desired by the homeowner.

The external heat pump unit contains a fan which will ramp up and down depending on the heating requirement. Care should be taken to ensure that no obstructions or obstacles are placed in the vicinity as this can affect performance. For further guidance, please refer to the Joule manual.

All equipment has been commissioned and preconfigured to ensure optimum efficiency and operation of the unit. The homeowner should only adjust temperature and time settings – any other adjustments should only be carried out by a qualified engineer.

# A GUIDE TO CONDENSATION

**Condensation is by far the most common cause of dampness in buildings, probably accounting for most dampness problems reported.**

Condensation is directly associated with mould growth, and it is this that the occupier first sees and gives an idea as to the potential scale of the problem. The mould is usually found on decorative surfaces, especially wallpapers, where it can cause severe and permanent spoiling. The mould and its spores ('seeds') cause the 'musty' odour frequently associated with a damp house and can sometimes give rise to health problems.

The obvious places for condensation to occur are on cold walls and floors, but sometimes it occurs in roof spaces and in subfloor areas where there is a suspended floor. Timbers in these areas will become damp and susceptible to damage by dry rot or wet rot.

While condensation is obvious when it occurs on impermeable surfaces - most commonly window glass, cold water pipes and ceramic tiles - it will also form on any surface which is at, or lower than, dew point. The presence of condensation on more absorbent surfaces (such as paint, plaster, and wallpaper) becomes obvious when disruption, damage or mould growth forms on that surface.

Mould growth is a typical sign of chronic condensation and occurs as spores which are always present in the air. Mould is a significant health risk to asthmatics, anyone with other respiratory conditions, the very young and elderly people. The high humidity levels associated with condensation also enables house dust mites to flourish. The droppings from these microscopic creatures as well as mould spores can cause allergic reactions which are also linked to the onset of asthma.

## The cause

It is a fact that warm air can hold more water as vapour than cool air. So, quite simply, condensation is caused when moisture-laden air comes into contact with a cold surface and the air is cooled to a point where it can no longer hold its burden of water vapour. At this point, (dew point), water begins to drop out of the air, and it is seen as condensation on surfaces. On impervious surfaces such as glass and paint, beads or a film of water collect, but on permeable surfaces such as wallpapered and porous plaster the condensing water is absorbed into the material. Therefore, the problem is initially not obvious.

If you do not take steps to reduce condensation it can lead to some of the common problems associated with dampness such as mould on walls and furniture. Damp housing encourages the growth of mould and mites. It can also increase the risk of respiratory illness.

## What actions are required?

Double glazing and improved insulation mean we have warmer homes, but unless a property is adequately ventilated, it can become damp. We ask all homeowners to ensure that their properties are sufficiently ventilated by taking a few precautions stated below to avoid condensation and the build-up of damp:

1. Do not block vents.
2. Turn on the extractor fan while cooking.
3. Open your windows for approximately 15 minutes each day to allow air circulation.

Each zone can be controlled independently via



# HEATING CONTROLS

**The heating system is configured to provide 1) hot water and 2) independent heating zones. The heating controls installation comprises a central heating programmer, zone thermostats and local radiator thermostatic valves.**

time and temperature settings. Time settings are adjusted via the programmer. Functions available to the homeowner are as follows:

Thermostats provide control of temperature in each heating zone. Thermostats are digital dial type. The homeowner can adjust the thermostat to the required temperature by adjusting the dial.

## Recommended temperature settings are as follows:

**Living areas:** 18 - 21 Degrees

**Toilets:** 18 - 21 Degrees

**Bedrooms:** 16 - 21 Degrees

The maximum temperature setting for all zones is 21 Deg C. The system is not designed to achieve temperatures above this setting. Please be advised that increasing the temperature will have an increase on your electricity bill.

Heating to each zone will be turned off when the temperature setting on the thermostat is achieved. If an increase in temperature is required, adjust the dial on the thermostat to the desired setting. This will ensure the

heating system continues to operate until the set temperature is achieved. Please note that towel rail radiators can only be turned on when the main heating is on. Do not place wet clothing on radiators if the windows are not open as this will affect the temperature regulation.

In addition to the thermostats, temperature-regulating valves are also provided on each radiator. These valves can be adjusted to increase or decrease the output of each radiator separately. Please note that there isn't a temperature-regulating valve on the master radiator as this would prevent the rooms from maintaining a balanced temperature.

Setting the radiator to a lower setting will reduce the heat output from the radiator, while raising the try setting will increase the radiator setting.

Changes to the radiator valves will not override the thermostat settings unless the radiator valve is turned to the closed position.

# WATER SYSTEMS

## Hot water

The heat pump generates hot water in the cylinder located in the hot press as per the image opposite. The dwelling is provided with a 200-litre hot water cylinder with a quick recovery coil ensuring ample hot water is always available. The hot water storage cylinder temperature is set at the commissioning stage so does not require adjustment. The heat pump controller will raise the water temperature to 60 Deg C on an anti-legionella cycle as required.

The homeowner can turn off all hot water generation by setting the holiday mode function on the programmer if the house is unoccupied for a period of time.

## Cold water

Mains water is supplied to the dwelling via the Irish Water main. The supply to the house can be controlled by an on/off switch (stopcock) generally installed in the public footpath outside your house.

A second stopcock is installed inside the house under the kitchen sink, which allows the homeowner to turn the supply off in an emergency, maintenance or incase there is a leak/weap. Please be advised that if a water softener is fitted onto the main supply, then Glenveagh are not liable for any leaks or issues within the vicinity.

From the internal stopcock water rises to supply the cold water storage cistern in the attic. A cold water booster pump is installed adjacent to the water tank from which all sanitary fittings are served. Only the kitchen tap is connected directly to the mains drinking water supply.



## Ventilation

The Fire Rated Ceiling Air Valves are a unique and cost-effective alternative to air valves with fire dampers. The Fire Rated Ceiling Air Valves offer a fire-rated solution where recessed ceiling air valves are to be installed in fire-rated ceilings.

In a fire situation, the integral intumescent material rapidly expands to seal off the air valve and reinstate the fire resistance rating of the ceiling. This limits the risk of fire and heat spread throughout the building.

- Extract and supply versions.
- 60-minute fire ratings.
- No maintenance required.



## SYSTEMS & EQUIPMENT

# MECHANICAL & VENTILATION SYSTEMS

Your new home comes kitted out with a range of different equipment and systems, all working together to keep your house a home. Find out how each of these systems works, right here.



### 1. Stop Valve

**Location:** Your inside stop valve is inside your house and is normally located just after the water pipe enters the house. This is often under the kitchen sink but can also be in an airing cupboard or under the stairs.

**Instructions:** To turn your water off, turn the valve clockwise. It

may take a few turns to stop the water, and it may also take a few minutes for the water to stop running altogether as there may be some water left in the pipes. To turn the water back on, turn the valve anti-clockwise and wait a few minutes for the water to start running again.

**Contact details:** Please contact Glenveagh Customer Care if you're experiencing any problems with your stop valve within 18 months, from the date that we notify you that the works on your home have been completed.

Email: [customercare@glenveagh.ie](mailto:customercare@glenveagh.ie)

### 2. Heat Pump & Cylinder System

**Location:** The internal cylinder which provides both hot water and heating to your home will be located in the hot press. The air-to-water unit, which heats the hot water cylinder, is located in the back garden.

**Instructions:** The hot water cylinder located in the hot press will provide both hot water and heating for your home. The hot water tank has a set temperature on the controller of the cylinder. Once hot water is drawn down the temperature in the tank will decrease. When the sensor for the hot water detects the temperature has dropped between 5-7 degrees of the set temperature, this will engage the air-to-water unit outside and bring the temperature back up to the set point. The heating is controlled by the downstairs and upstairs stats. Each stat should be set at a required temperature and left at that temperature. Once the temperature drops below the set point the air-to-water unit will engage to bring it back up to the set point of the stats.

**Maintenance:** The Cylinder/Indoor unit requires annual servicing to ensure safe working and optimum performance. All checks must be performed by a competent installer on an annual basis.

This is commonly done at the same time as the annual heat pump service.

**Warranty:** The air-to-water unit has a 7-year parts & labour warranty. The hot water cylinder has a 25-year warranty and the moving parts pumps. Motorised valves have a 2-year warranty. All are subject to annual service by a Joule-accredited engineer.

Glenveagh Customer Care will assist you with any issue in relation to this appliance for a period of 18 months from the date that we notify you that the works on your home have been completed.

**Contact details:**

**Email:** [service@joule.ie](mailto:service@joule.ie)

**Phone:** (01) 6237080 and press 3

### 3. Mechanical Extraction Ventilation

Location: InvaVent Mechanical Extraction Ventilation unit is generally installed in the roof space and ducted to all wet rooms. The low-energy unit runs at a low ventilation rate continuously extracting stale polluted air from rooms where the most moisture is generated e.g. kitchens and bathrooms.

**Instructions:**

- Fresh air is provided from the outside to habitable rooms by trickle vents fitted in the wall.
- The background ventilator must be in accordance with TGD F F(i) 1.2.2.8: "For any design air permeability, controllable background ventilators having a minimum equivalent area of 2,500 mm<sup>2</sup> should be fitted in each room, except wet rooms, from which air is extracted."

- The extract air is ducted with 204/60mm or 125mm from the wet rooms to the outside through a centralised mechanical ventilation unit.
- The extract rate is boosted at times when excessive moisture is being generated.
- The fan can be adjusted at the unit and at the valves to ensure the correct ventilation rates are achieved in accordance with TGD F.
- A 10mm cap minimum underneath the doors is required for air transfer between rooms.



**Warranty:** There is a 3-year warranty on the box and the electrical components.

**Maintenance:** Before (possibly) proceeding to clean your extract unit, as the householder, you need to inspect it to establish whether it is necessary. Your MEV system needs to be cleaned by an accredited installer. The homeowner must ensure nothing compresses ductwork visible in the attic space. No items are to be left on top of the fan unit or ductwork. This could have a serious impact on ventilation performance and void the system warranty. As part of routine maintenance, visually check that all ducts are connected and identify any damage or disconnection to ductwork.

**Contact details:**

**Email:** [info@joule.ie](mailto:info@joule.ie)

## MECHANICAL & VENTILATION SYSTEMS FAQ

More information on your home's equipment and systems.

**Is my heat pump and cylinder registered?**

They are registered when commissioned, prior to the customer moving in.

**What do I do if I have an issue with my heat pump or cylinder?**

Contact Joule on the number/email given in the earlier parts of the information.

**What is the average temperature for the radiator?**

The average surface temperature of a radiator will be substantially less in a house heated by a heat pump compared to a conventional gas boiler. The radiators in your house will have an average surface temperature of approximately 40 Degrees and will be lukewarm to touch. This is normal and allows the heat pump to run with high efficiency and low cost. These are the design settings and the heating system is not designed to provide temperatures in the dwelling above these set points.

**What is my standard warranty and extended warranty period for Joule products?**

The warranty period starts on the date of expiration as shown on the commissioning report. The standard warranty period ends 24 months later. By registering the product(s) you will receive an additional 5-year extended warranty which will bring the total period of coverage to 7 years from the date of installation. All of the terms set in this Statement of Limited Warranty shall apply to any extended warranty. The method of service and operating conditions will be described in the original warranty statement provided with the Samsung product.

Note: all heat pumps commissioned by Joule are registered for extended warranty automatically. Proof of extended warranty is in the form of a Joule commissioning certificate.

All Samsung Air Source heat pumps supplied by Joule must be serviced annually to maintain the product warranty under the terms of the EUW Agreement.



# WALRUS HQ SERIES ELECTRONIC CONTROL PUMP

## Product

The HQ series is designed for the pumping of non-aggressive water, or water not containing solid particles.

## Operation and maintenance

The mechanical seal and shaft sleeves are lubricated by the pumped liquid. Under normal operating conditions, the pump does not require any maintenance as long as the following points are observed:

1. Periodically check the condition of the check valve and strainer (if used).
2. If the pump is to be inactive for long periods, it should be rinsed thoroughly with clean water, then, drained and stored in a dry place.

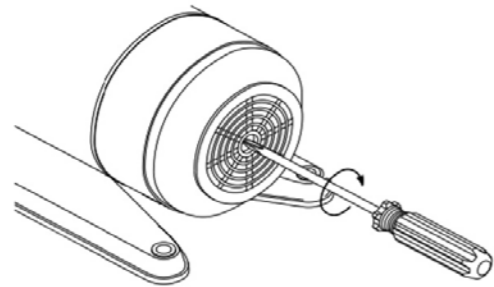

Figure 3

3. If the pump sticks after periods of inactivity, a screw driver slot is provided on the motor shaft end to free up the pump/motor. To do so, insert a screw driver in the slot in the motor shaft as shown in Fig 3 and turn to free the rotor. If this does not remedy the problem, the unit will need dismantling.

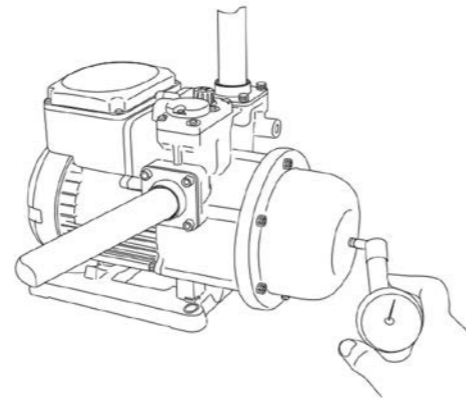

Figure 4

4. Pressure tank air charge should be checked at regular intervals of every 3 months and after the pump has not been used for a prolonged period. To check the Pressure Tank air pressure, turn off the power, open a tap on the discharge line to release pressure from the pump, unscrew the black plastic cover and apply an accurate pressure gauge to the valve as shown in Fig 4.

# ELECTRICAL SYSTEMS

From smoke alarms to general lighting, your home is kitted out with a range of electrical systems - read on to learn the basics.

## I. Consumer Unit

### Location:

The Consumer Unit is located in the utility room near the ceiling.

### Instructions:

The switches on the consumer unit will be labelled by the electricians prior to moving in. This will inform the homeowner which switches they are turning off and on should the need to do so arise.

### Maintenance:

Annual service to be organised by the homeowner with a registered electrician.

### Warranty:

There is no warranty required on consumer units.

**Glenveagh Customer Care will assist you in any issue in relation to this appliance for a period of 18 months from the date that we notify you that the works on your home have been completed.**

## 2. Smoke Alarms

### Location:

Smoke alarms are mains powered and distributed on the ceiling throughout the home.

### Instructions:

The homeowner should check regularly if they are in working order and change the batteries if necessary.

### Maintenance:

Ensure the detectors in your home are working, testing them twice a year.

### Warranty:

5-year warranty with Hager Electrical.

### More information:

The dwelling has been fitted with mains Operated Smoke Alarm with battery backup in all habitable rooms with Heat detectors installed in the kitchen. To check that this alarm is working, press its button hard for 3-4 seconds. This check should be carried out twice a year to ensure that the alarm is fully operational

If your smoke detector/alarm is making a "bleeping" sound every 40 seconds and a flashing red light, this indicates that the backup battery has expired or is incorrectly fitted and should be replaced or refitted immediately.

### 3. Photovoltaic Panels

Photovoltaic Panels (or PV Panels as they are commonly referred to) are installed on your roof. PV panels capture the light from the sun and convert it into the electricity that is used in your home to power your TV, kettle, toaster, radio, oven etc. The electrical energy created by the PV in your home will always be used first and any extra energy required will be imported from the grid. When excess electrical energy is being produced it will automatically be exported back to the grid.

The number of PV Panels provided to your home is based on the orientation of your home, the BER requirements and the output of the panels. There is a control panel on the fuse board to show you how much is being generated each day. When signing up with an electrical provider, please notify them that you have PV Panels to see if a repayment scheme is available for your excess energy exported to the grid.

### 4. Lighting

#### Location:

Much the same as the smoke alarms, the lighting in the house is low energy and distributed throughout as per the electrical drawings.

#### Instructions:

On and off switch. Maintenance: Check bulbs regularly and replace them if necessary.

#### Warranty:

2-year warranty with Robus Lighting. Glenveagh Customer Care will assist you with any issue in relation to this appliance for a period of 18 months from the date that we notify you that the works on your home have been completed.

#### Contact details

Contact: **Hager**  
Phone: **086 608 3981**  
Email: **michael.bissett@hager.com**

Contact: **Robus Lighting**  
Phone: **086 825 6558**  
Email: **ssweeney@robus.com**

### Lighting schedule



#### Supplier: Hager

Location: Utility / Living Room / Dining Room / Hallways / Bedrooms  
Description: A lone light fixture hanging from the ceiling suspended by a cord.

#### Supplier: Luceco

Location: Downstairs WC / Bathrooms / Utility / Hot Press  
Description: ECO Decorative indoor IP54 LED Bulkhead Light.  
Colour: White moulded with Chrome bezels.



#### Supplier: Robus Lighting

Location: Kitchen / Dining Room  
Description: LED Downlighters (Fire rated 60 minutes.)  
Downlights consist of fire-rated units to eliminate any additional fire rating box outs within the ceiling void on site.



### SYSTEMS & EQUIPMENT

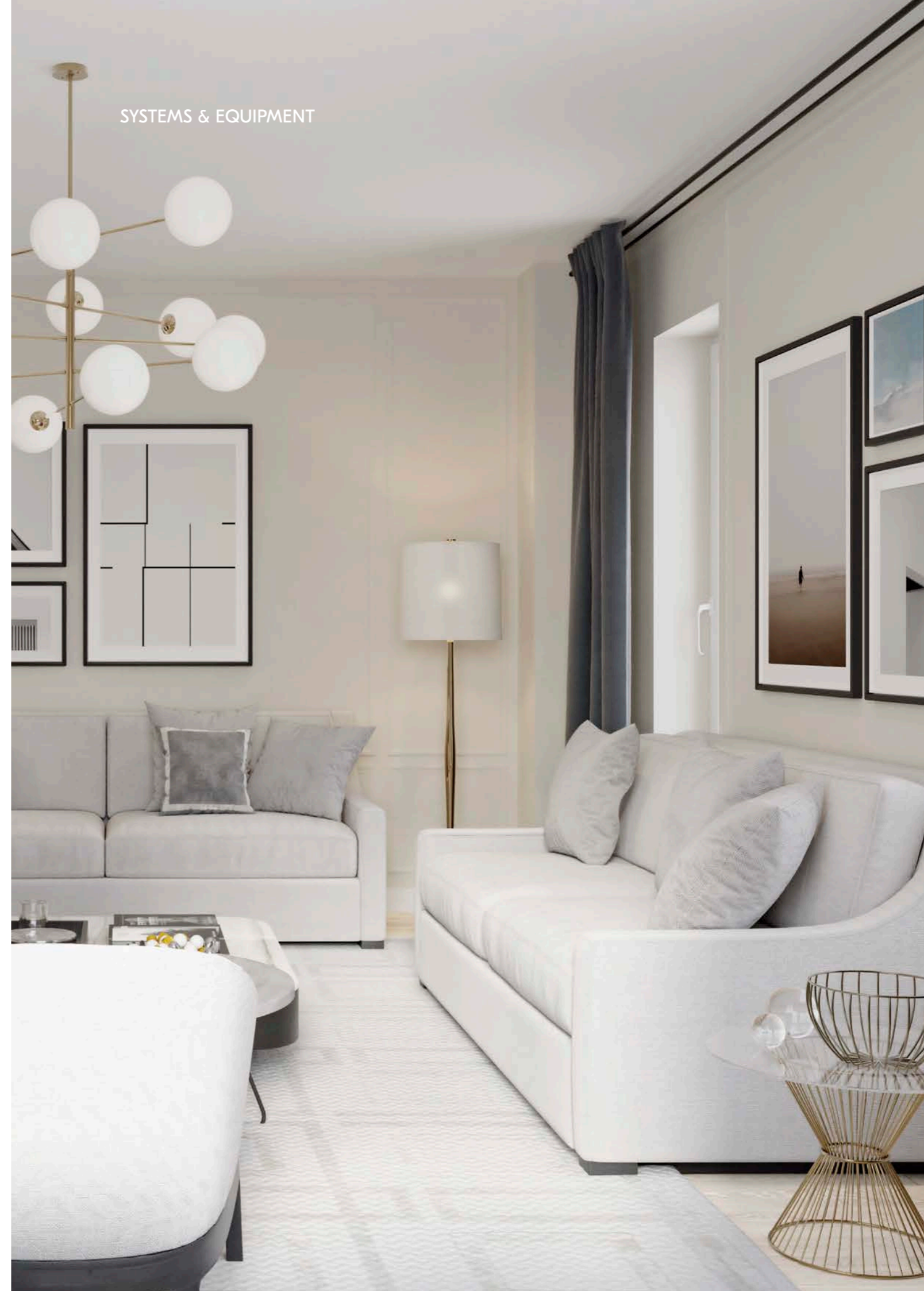

# ELECTRICAL INSTALLATION

## Electrical wiring and protective devices

The electrical supply to the dwelling is via underground ducting which enters the dwelling at the external metering location. The fuse board for the house is inside the front door/utility and all fuses and protective devices are contained here.

An MCB can be reset to the upward ON position when the fault is identified and repaired.

Additional protection is provided on socket circuits by a Residual Current Device (RCD) which is an earth leakage apparatus which provides additional shock protection for certain circuits (e.g. immersion, shower) and appliances used outside the home.

Should this type of failure take place, then this RCD will trip out and turn off the whole electrical supply to your home.

The main switch turns off the Consumer Unit completely. The RCD switch controls just the power (Protected side).

All RCDs have a test button to check that the mechanism is working properly. This test button should be operated at regular intervals of once a month. Remember to reset the switch after testing.

Repair work on the fixed electrical installation or to electrical appliances should only be carried out by a competent, qualified and registered person and should not be attempted by a layperson.

## TV/Phone

There are telephone points in the hall, living room and the main bedroom.

The homeowner will need to contact the preferred telephone and broadband supplier to create an account and activate TV and phone services.

## Doorbell

There is a doorbell situated on the exterior of the building, by the main entrance. have been completed.





## LIGHTING CONTROL

**Stainless steel sockets above the counter level in the kitchen area only.**



### Switch control ports

10AX 1 Gang 2 Way Wall Switch Polished Steel White Insert.



### Double switch

13A 2 Gang Double Pole Switched Socket Brushed Steel.



### Double switch with double USB point

13A 2 Gang Double Pole Switched Socket c/w Twin USB Ports Brushed Steel.



### TV outlet

Raised plate TV outlet, Brushed Steel.

## LIGHTING FAQ

### Can I carry out electrical work in the home?

Any electrical work in your home must be carried out by a certified installer and company with the building and wiring regulations.

### What should I do if the electricity goes in my home?

Check the circuit breakers on your fuse board, if there are no fuses or switches tripped then call ESB Networks and report the power outage through the process on their website.



# KITCHEN OVERVIEW

Your home has been provided with top-of-the-range appliances. Learn how to understand, clean and maintain your kitchen with confidence.



## KITCHEN

# SOLID SURFACE COUNTERTOP WARRANTY INFORMATION

**A solid surface countertop consists of mineral dust - mostly marble - mixed with a variety of plastic resins and pigments. The great appeal of a solid surface is that it is easy to fabricate and can create invisibly seamed countertops that look great.**

Gallagher Kitchens offers, as standard, a 1-year defects and damage warranty on all new solid surface countertops fitted on development sites. The warranty is valid for one calendar year from the date of purchase of the property. Homeowners are advised to never kneel, sit or stand on a countertop as this may cause cracking and will void the warranty.

**This warranty applies to any solid surface countertop but does not apply to damage caused by the following:**

1. Accidents or misuse
2. Damage from heat
3. Breakage not due to a defect in the material or fitting
4. Improper care and maintenance.

The company will repair or replace, at its discretion, any fitted countertop found to contain a manufacturing or fitting defect within the period of the warranty.

### Care guide for solid surface

A solid surface composite countertop is a man-made material, composed of acrylic resin. This material is more resistant to surface damage than other materials but better care will make for a longer life. Worktops are buffed to achieve an aesthetically pleasing matte finish with no need for sealing.



## KITCHEN

# LAMINATE COUNTERTOP WARRANTY

**Gallagher Kitchens offers, as standard, a 1-year defects and damage warranty on all new laminate countertops fitted on development sites. The warranty is valid for one calendar year from the date of purchase of the property.**

### Cleaning

Worktops are non-porous and can be wiped down with household cleaning liquids. Specially formulated cleaners for 'solid surface composites' can also be used.

For most staining, a simple soap and water solution on a cloth or sponge will suffice. For trickier stains, a stronger cleansing agent may be required. It's advised to soak the stained area in an abrasive cleaner for about 10 minutes, use a cloth or sponge to rub the area in a circular motion carefully and then rinse thoroughly. Do not expose the surface to harsh chemicals and if contact occurs, flush the countertop with water. Never use steel wool on a countertop.

To prevent a soap film or residue, it's important to dry the surface thoroughly after cleaning as residue streaks can leave behind what looks like light scratches. To remove hard water deposits, it's best to use a wet cloth with a mixture of one part vinegar to three parts water and then dry the area with a clean dry cloth.

### Minor damage

A scratch that can be felt by touch should be addressed by a professional fabricator. To avoid scratching, it's advised to always use a cutting board instead of cutting directly on the surface. Use felt pads on canisters, pottery, etc. to prevent scratching on the surface.

### Heat tolerance

Always use a hot pad or trivet with rubber feet to protect the surface from heat. Hot pans and heat-producing appliances may cause discolouration or cracking which will void the warranty.

### Care

Scratches and small chips from sharp utensils may occur over time through general use but can easily be removed by a professional fabricator by sanding with a sanding sponge for fine scratches, and sandpaper for deeper scratches and small chips.

If the material becomes cracked or broken, a solid surface can, in most cases, be repaired quickly by a certified solid surface repair company or trained fabricator.

Plastic laminate countertops are durable man-made surfaces, but like any product, they can be damaged by misuse. It's advised to never kneel, sit or stand on a countertop as this may cause cracking and will void the warranty.

This warranty applies to any laminate countertop but does not apply to damages caused by the following:

1. Accidents or misuse
2. Damage from heat
3. Breakage not due to a defect in the material or fitting
4. Improper care and maintenance.

The company will repair or replace, at its discretion, any fitted countertop found to contain a manufacturing or fitting defect within the period of the warranty.

All repairs must be specifically authorised before being undertaken.

Mitre joints in laminate countertops require silicone sealing once a year to maintain their water resistance. This is the responsibility of the homeowner.

### Care guide for laminate

Countertops should be cleaned with a damp cloth or sponge and a mild detergent. Cleaners containing ammonia, bleach, or abrasives should not be used. The countertop should be wiped with a clean, damp cloth and dried with a non-abrasive cloth. Abrasive cleaners and products such as steel wool should never come into contact with laminate.

### Stain removal

Difficult stains can be removed using a mild household cleaner and a soft bristle brush. To remove any residue it's important to rinse thoroughly and dry. Never use cleaners containing acid, alkali or sodium hypochlorite. Hair, textile and food dyes can also cause permanent stains and if they come into contact with laminate wipe up immediately and rinse several times with water. It's advised not to use abrasive cleaners, powders, steel wool, sandpaper or scouring pads on the laminate surface.

## KITCHEN

### Minor damage

Ceramic and abrasive objects can cause scratches and premature wear. It's not advisable to chop, slice, pound or hammer on the laminate surface as sharp utensils will scratch or slice the surface. Heavy blows may crack or gouge the surface. To protect the countertop it's best to use cutting boards, chopping blocks or other protective equipment.

### Heat tolerance

Hot items should not be placed directly on the laminate surface and protective insulated pads should be used instead. Extreme heat can cause cracking, blistering, burns and discolouration and these are irreversible. Electric heat sources such as kettles, skillets, and irons used directly on the laminate surface can damage it.

### Water damage

Water that is allowed to sit on the countertop for any length of time, especially near mitre joints, can penetrate and cause the core of the countertop to swell and delaminate so it's advised to always wipe it immediately. Care should be taken in areas where sinks, dishwashers, coffee makers, toasters or kettles are located on or near a mitre joint. Water or other liquids should be wiped off immediately. Damage caused by excessive water in the seam area is not covered under warranty.



## EXTRACTOR FANS & HOBS

### Extractor Fans

Extractor fans should always be used while cooking.

- We recommend that you switch on the cooker hood up to five minutes before you start cooking to start the air circulation. You should also leave the hood on after you have finished cooking to clear away lingering smells and steam in the kitchen.
- It's important to maintain the fan by changing or cleaning the filter in line with the manufacturer's instructions.
- It's really important to note that lids should be used on pots. Homeowners should expect excess steam, especially with induction hobs, this is easy to wipe away with a dry cloth.
- The grills should be cleaned regularly as a build-up of grease will occur and decrease the extraction rate.

### Charcoal Filters

Where venting is not possible, the use of charcoal filters allows the air to be recycled. Charcoal filters are available online to suit whichever cooker hood you choose.

### Induction Hobs

If choosing an induction hob, we recommend that you check which fan you have selected or comes with your kitchen package as you may need to upgrade your extractor fan if you do a lot of hob cooking. Please note that each extractor fan has been tested and is performing as per spec with a high extraction rating. In order to upgrade your extractor fan, please contact Kube directly.

It is of particular importance to switch your fan on 5/10 minutes before starting to cook to help reduce condensation. If the excess steam is not removed with a dry cloth, damage may occur to the kitchen materials in the long term.



## KITCHEN

# CABINETRY WARRANTY INFORMATION

**Gallagher Kitchens offers, as standard, a one-year defects and damage warranty on all new kitchen and wardrobe cabinetry and fitting components fitted on development sites. The warranty is valid for one calendar year from the date of purchase of the property.**

This warranty applies to any kitchen or wardrobe component but does not apply to damages caused by the following:

1. Accidents or misuse
2. Damage from heat
3. Breakage not due to a defect in the
4. material or fitting
5. Improper care and maintenance.
6. The company will repair or replace, at its discretion, any fitted component found to contain a manufacturing or fitting defect within the period of the warranty.

All repairs must be specifically authorised before being undertaken.

### Care guide for painted and laminate cabinetry

- ALL carcasses are made from 18mm MDF with 100gr melamine bonded onto it with 2mm PVC edging to the front face.
- Painted doors are Shaker MDF hand-painted, or finish spray-painted.
- Laminate doors are Slab doors made from MFC bonded onto it with 2mm PVC edging.
- The hinges used are “Blum” and the drawers are “Alto”

### Tips for cleaning

- The cabinet interiors can be cleaned with an abrasive cleaner.
- Doors should only be cleaned with washing-up liquid and warm water.
- Interiors and exteriors should be wiped dry immediately after cleaning.
- A clean, microfibre cloth should be used for regular dusting.
- Hardware should be cleaned with a solution of warm water and mild dish detergent applied to a damp microfibre cloth.
- Brass and silver cleaners are not recommended.

### Everyday maintenance

- Cabinet shelves and drawers should not be filled with heavy loads.
- Door-mounted storage accessories should be avoided unless the cabinet has been specifically designed for this.



### Appliances and heat/steam damage

- Heat and steam can damage many components of a kitchen.
- When cooking the vent should always be turned on, or the range hood or extractor fan used.
- Hot items and electrical appliances should not be placed directly on the countertop and protective trivets or chopping boards should be used.
- Heat and steam-producing appliances such as toasters, kettles or coffee makers should not be placed directly below the upper cabinets. This will help prevent damage to the finish, edging, and doors of the cabinet.

### Exposure to sunlight

- Blinds or shades should be considered to prevent discolouration of cabinetry.
- Exposure to direct sunlight can darken the colour of natural wood products, fade painted surfaces, laminated surfaces and thermofoil surfaces.

### Water damage

- Prolonged exposure to spills, including food, water or other liquids can cause permanent discolouration or damage so cleaning should be done quickly.
- Damp or wet dish towels should never be draped over the doors of cabinets as over time this moisture can cause permanent water damage.
- Extra attention is required around susceptible areas such as sinks, drainers, dishwashers and food preparation areas.



# MAINTENANCE & CARE GUIDE

Information to help you maintain and care for your new Glenveagh home.



## WINDOWS & DOORS

The bedroom windows in your house have fire escape windows which are designed to ensure safe egress in case of fire. These windows are also fitted with a restrictor which limits the initial opening of the window to 100mm. This provides protection from falling to small children. These measures are necessary in order to comply with Part B of the Building Regulations in regard to Fire Safety.

It is important that the householder makes sure all occupants are familiar with these restrictors and can release them in case of fire.

### To release the restrictor:

1. Open the sash out as far as the restrictor will allow
2. Then pull the sash back in slightly – (10 – 12mm, 1/2" ) to line up the pin with the opening slot in the restrictor arm
3. Finally pull the restrictor arm inwards.

This releases the restrictor and allows you to open the sash fully. The restrictor will automatically engage when you close the sash again.

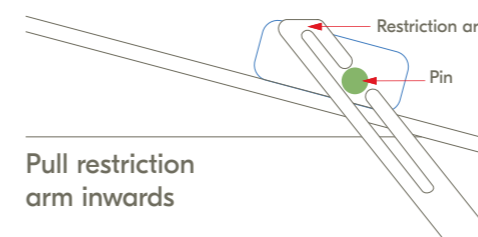
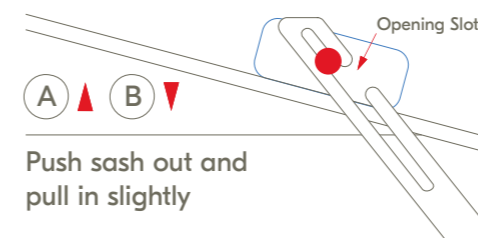

**Important Note: Solid timber doors are made from natural materials and must be afforded protection from the elements. In exposed locations, the door must be recessed from any façade of the building which is facing into the elements. This applies particularly in coastal locations.**

### Maintenance

1. This is a factory-finished product. The surface must be brush-coated with one coat of solvent-based paint to give added protection after installation. The manufacturer states to use Sikkens Filter 7 on translucent finishes and Sikkens Satura or any good quality exterior paint on opaque finishes. This repairs any damage or wear to the coating occurring during the build process. It gives a very good decorative finish, prolongs the coating life and gives added protection against moisture damage.
2. Inspect windows at least annually. Pay particular attention to lower areas, glazing beads and sill. Repair any small patches of coating damage promptly.
3. Wash surfaces with a solution of warm water and liquid detergent – change the water frequently. Rinse thoroughly with clean water. The build-up of dirt on joinery surfaces encourages mould growth.



4. Check joinery for signs of algae or mould growth. Treat affected areas with a solution of one part household bleach to two parts water. Allow 20 minutes to act and wash off with cold water and a stiff nylon brush. This is important on building facades which are exposed to cold and damp. Unchecked mould growth may damage the coating and penetrate the timber to cause permanent damage.
5. Redecorate when the lower parts of the joinery show general signs of wear. The time for this to happen will depend on climate and level of shelter. Redecoration time must be based on physical inspection. Apply two coats of good quality exterior paint - sanding between coats with 280 grit sandpaper.
6. Timber is a natural product – it expands and contracts with varying climatic conditions. With a panelled door, this may cause lines on paintwork around the panel. Sand down any unevenness and touch up the coating in this area.
7. Keep moving parts – hinges, locks, handles etc. clean and free of grit, dirt or mortar. Clean regularly. Apply an acid-free oil, Vaseline or a silicone lubricant to all moving parts at least once a year. Do not lubricate the balance channel on sliding sash windows.

8. Do not paint over rubber gaskets or ironmongery.
9. GRP doors need to be inspected annually and redecorated with two coats of good quality exterior paint if there is any evidence of coating wear.

### Operation

It is important to ensure that multi-point locking is used correctly. The handle must be turned upwards to engage all the operating points whenever the door is closed. This ensures security and protects the timber against warp and bowing.

### The Glazing Unit

The manufacturers guarantee this product for a period of ten years from the date of installation. Should any defect arise due to faulty materials or workmanship during that period a replacement unit will be provided by the manufacturer.

**Glenveagh Customer Care will assist you in any issue in relation to this appliance for a period of 18 months from the date that we notify you that the works on your home have been completed.**

### Terms & Conditions

#### This guarantee does not cover:

1. Any damage accidental or deliberate occurring on site after installation and specifically excludes damage to timber or to coating caused by cleaning practices or application of any chemicals or abrasive substances.
2. Any damage to timber or to coating caused by other operations in the build process and specifically excludes damage by cement, mortar, render or any cleaning operation to remove these substances failure of hinges due to the build-up of cement, mortar, sand, grit or any other building debris in the moving parts.
3. Failure of moving parts due to not having been lubricated regularly.
4. Corrosion or discolouration of ironmongery caused by cleaning agents, chemicals or dirty water, from cleaning operations.
5. Faults on products which have not been maintained according to Munster Joinery maintenance guidelines. The end user of this guarantee is responsible for the maintenance and cleaning of the product.
6. Problems relating to the installation of products by personnel other than trained Munster Joinery staff.
7. Visual defects in glass, such as scratches or marks, which are not reported within 48 hours of installation. Such defects must be assessed according to the GGF Visual Quality Standards.
8. Any visual defects in the product that are not reported within three days of installation in writing.
9. Any damage caused by condensation being deposited on windows and doors. Condensation is an indication of excess moisture in the building and is not a window problem.
10. Variations in the colour and grain of timber. Timber is a natural material – each tree grows under different conditions to a different shape and size. This makes variations in the colour and grain unavoidable.
11. Damage to outward opening doors due to being left open in windy or breezy conditions.
12. Damage to timber flooring fitted within one metre of an inward opening door.
13. Redecoration of items or components which have been replaced or their surroundings.
14. Any product which has not been paid for in full.

# EXTERNAL CONDENSATION

With improvements in the thermal performance of glass, the phenomenon of condensation on the exterior surface of glazing has become more prevalent. External condensation occurs in particular climatic conditions with high humidity levels and/or particularly cold weather. It is not a defect in the glass or the windows but it does demonstrate that the item is doing the job it's supposed to do – keeping heat in.

The low emissivity inner pane reflects heat back into the building preventing the outer pane from warming up. The outer pane presents a cool surface and, given the right temperature and humidity conditions, water vapour from the air will condense on it.

This was not an issue with traditional double glazing when there was much more heat loss through the inner pane so that the outer pane was warmed up by this wasted energy. Today, because of energy prices, global warming, and the need to comply with building regulations and reduce carbon emissions, it is no longer possible to install inefficient glazing. In Northern European countries which have much colder winters than we do, glazing with very low U-values has been used for some time and the phenomenon of external condensation is understood and accepted. It is considered much more important to conserve energy and have a warm comfortable indoor environment.

Customers are sometimes perplexed by the fact that condensation may occur on one

house but not on another, on one window but not on another, and indeed even on one pane but not on another. This happens because the surface temperature of the glass is affected by the degree of shading from a roof overhang, a projecting reveal or lintel, a tree, another house or by a very minor difference in orientation.

There is nothing that can be done to predict where external condensation will occur or to avoid it. It does however indicate that the glazing is very energy efficient and is saving money by conserving heat. In most cases, the condensation will disappear as soon as the window is exposed to a little sunshine or a breeze.

Munster Joinery offers an excellent customer care service that is competitively priced.

Should you need to contact Munster Joinery with regard to your windows and doors at any time, it will be faster and easier both for you and for the operator if you can quote your contract reference. This can be found printed on the spacer bar that separates the two panes of glass in your double-glazed units.

The string of numbers on the bar is in the following sequence:

Date Size MJ BS EN1279 KM30858

**Contact Details:**

**Phone: 064 7751151**

**Fax: 064 7751360**

**Email: [info@munsterjoinery.ie](mailto:info@munsterjoinery.ie)**

# INTERNAL CONDENSATION

Nowadays because of the improved airtightness of buildings coupled with changing lifestyles, more people are experiencing difficulties with condensation.

Because this problem frequently manifests itself in windows and doors, there is a tendency to regard windows and doors as being in some way responsible. This is a totally erroneous viewpoint.

Condensation is water vapour from the atmosphere in the building and cannot possibly under any circumstances be generated by windows or doors. It is introduced into the air inside the building by the users of the building carrying out such activities as breathing, cooking, washing, showering, bathing, drying clothes etc. In the case of a new house, the amount of water vapour generated by the users is significantly added to by the materials used in the construction of the house itself drying out. When the house is warm the air accepts this water vapour until it reaches saturation point. As the house cools down the saturation point of the air drops and it can no longer hold the amount of water vapour, which it accepted, when warmer. This excess has to be deposited on the various surfaces in the room and the cold glass surface provides an ideal surface for this.

The formation of condensation on a surface does not indicate any problem with that surface – it merely indicates the presence of excessive levels of water vapour in the air. Any surface will condensate given the right combination of two factors - the difference between indoor and outdoor temperature and the relative humidity of the environment. For example a particular glazed element will not condensate for an outdoor temperature of  $-2^{\circ}\text{C}$  and an indoor temperature of  $20^{\circ}\text{C}$  at a relative humidity of 50%. If however the relative humidity is increased by a mere 2% (eg. boiling kettle, unloading dishwasher or similar) condensation occurs.

Windows and doors can help recognise and deal with a condensation problem. Initially, the

formation of condensation on windows and doors provides an early warning that there are excessive amounts of water vapour at large in the building. They provide a clean wipeable surface on which condensation may form without causing a lot of damage, unlike more porous surfaces such as paintwork, presses, clothes, furniture etc. Condensation forming on a window or door surface will cause a lot less structural damage than elsewhere in the building. The presence of heavy condensation on a window or door is a symptom of a problem with moisture control in the building - heed the warning but do not shoot the messenger!

The solution to condensation lies in maintaining the correct balance between heating and ventilation in a building and limiting activities which give rise to the build-up of excess water vapour. Heating creates a situation where the air in the building can absorb a lot of water vapour and ventilation ensures that as the air cools down the excess water vapour can escape instead of condensing on cold surfaces within the building.

A particular problem with moisture control may arise in a new building as the materials in the building itself go through a drying-out process which may take a year or two. If this proves too difficult to manage by normal means, a dehumidifier will help to control the problem.

**Remember these points:**

- Windows and doors do not cause condensation.
- Windows and doors are safe, clean surfaces on which condensation may form.
- Condensation on windows and doors provides an early warning of a moisture control problem.
- Windows and doors can be used to provide adequate ventilation to solve a condensation problem.

# LAWN CARE

**A great lawn can create a fabulous impression of a house but can also be very high maintenance. A new lawn requires care and attention until the sward is established and should not be heavily used until it has been established.**

## Mower

Thinking about the best type of mower depending on a particular lawn can make a difference. The different types of mowers include:

- Rotary: For longer grass on a rougher or sloped lawn.
- Hover: For small gardens and a good finished look.
- Cylinder: For a well-maintained, level lawn a roller can be included to create stripes in the lawn. They can all be purchased with a roller to create stripes in the lawn.

## Robotic Mower

Robotic mowers are becoming increasingly popular and cut the lawn regularly at a low level. They are a small rotary mower but it should be noted that they are not suitable for a new lawn as the frequency is too high and setting too low to maintain a thick sward and weeds will enter the lawn.

## Cutting

It's important not to cut the lawn too low in the beginning as it establishes itself. Ideally, the mower should be set to cut on a high setting at first and then lowered as the sward thickens. The lawn should be cut in a different direction each time. In the initial weeks, weeds may appear in the lawn but this is normal.

## Fertilise

There are a number of preparatory fertilisers on the market for spring and autumn. Most

are a weed killer and grass feed combination. However, there are alternative products available such as Soil Renew which is a combination of organic plant matter and an ecosystem of microorganisms which creates humus in the soil. This will improve soil structure and combat any compaction that results from heavy use. It is organic and poses no risk to the health of humans or pets.

## High traffic

High-traffic areas on lawns will inevitably compact and develop bare patches. If this occurs the soil will need to be loosened and reseeded at the beginning and end of the year.

## Lawn maintenance

For worn patches, pushing the prongs of a garden fork into the soil, about 100-200mm deep will gently loosen the soil and allow it to breathe.

## How to improve your gardens drainage

Your new garden needs time to develop, with the unpredictable Irish weather and the rain that comes with it, it can cause poor drainage. There are many ways you can improve the drainage in your garden to maintain a green lawn once spring times comes around.

- Aerating or spiking the lawn by creating small holes to allow air, water and nutrients to reach grass roots to break down compacted soil.
- Adding organic material such as compost is a great soil additive to improve drainage as it absorbs moisture.



## Driveway cleaning

Cobblelock paving creates a great aesthetic for the driveway at the front entrance. The blocks used in the paving are laid in sand and a thin silica sand is then used to fill the narrow joints between blocks. This silica sand prevents the growth of weeds within joints and increases the stability of the individual blocks themselves to deter movement.

## Here are some top tips for cleaning your driveway effectively:

1. Sweep away any sticks, rocks or leaves.
2. Create a mixed solution of brick cleaner and water and follow the mixing guidelines clearly.
3. Wet the ground before commencing cleaning.
4. Pour the mixed solution over the entire area being cleaned.
5. Brush the area vigorously with a scrub or grill brush.
6. Wait 20-25 minutes for the solution to die out.

Month that keys are received	Season	First Cut	Second Cut	Third Cut
January	Winter	Late Feb early March, weather depending		
February	Winter			
March	Spring	Mow when the weather is dry and warm	Two weeks following the first cut	Mow at fortnightly periods until the weather improves
April	Spring			
May	Spring			
June	Summer	Mow when the weather is dry and warm, increase the height of the cut if high temperatures	Mow weekly to encourage growth	Mow at increased height if temperatures are high Mow weekly to encourage growth
July	Summer			
August	Summer			
September	Autumn	Mow when weather is dry and warm	Final cut of year weather-dependent	Final cut of year weather-dependent
October	Autumn			
November	Autumn			
December	Winter	Late Feb early March, weather depending	Two weeks following the first cut	Mow at fortnightly periods until the weather improves

Month keys received	When to fertilise	When to plant trees
January - February	Spring and Autumn feed	November - March
March-August	Autumn feed, spring feed the following year	
September - December	Spring feed the following year	

## MAINTENANCE & CARE

# TREE CARE

### Watering

It is not only dry, hot weather that causes trees to struggle for water. High winds will cause trees to dehydrate through the leaf surface. A low water table because of a season of low rainfall can cause new and established trees to struggle.

Trees require watering in their first year in the garden. They may require watering in subsequent years in times of drought.

Trees require a minimum of 50L of potable water per day. Do not use contaminated water.

Increasing the amount of water per tree and thoroughly soaking the ground allows you to space out the watering operations to every 2 or 3 days depending on weather conditions.

It is important to remember that dry soil 'caps' cause water to run off rather than percolate into the ground. Therefore, do not let the soil completely dry out or crack and cap.

Rainfall is not a substitute for watering in the first year.

### Mulching

When establishing, a tree's greatest competitor for water and nutrients is grass. Maintain a circle at the base of the trunk; at least 1m in diameter free from vegetation. This area can be mulched to help the ground retain moisture and remain weed and grass-free. The ideal mulch is well-rotted manure or compost as it contains beneficial nutrients and bacteria.

Maintaining this 'clean' circle around the base of the tree also makes mowing easier.

### Mowing around trees

Never strim around the base of a tree.

A tree with a bark wound greater than 1/3 of the total circumference will not survive. Strimmer damage to the bark will introduce disease into the tree and cause it to fail over a period of time. These wounds are also incredibly unsightly.

### Tree pruning

Tree pruning should be undertaken by a professional because it can result in disease and fungal infection being introduced into the plant. However, please be advised that it is no longer considered best practice to 'top' trees anymore.

The height should be reduced by regular tipping out of the main leader.

### Leaf fall

Leaves should be gathered up in the autumn and composted. Leaf buildup can result in surrounding plants and lawn being smothered. Leaf mulch is an excellent soil improver. However, please be aware that as organic material breaks down the process takes nitrogen from the soil. You only spread leaf mulch after the breakdown process is completed.

## SUSTAINABILITY

### A lightbulb moment

There are many simple ways to reduce lighting use and costs:

- The lighting installed in Glenveagh homes is low energy. When replacing light bulbs, it's important to purchase low-energy bulbs such as LED.
- Think about 'task lighting'. For example, when reading, the whole room doesn't need to be lit up — a book light or reading lamp can be a good solution.
- Switching off lights when moving around the house and not leaving lights on in unoccupied rooms can save energy and money.
- Keeping lights clean can make a huge difference to light levels.
- Sometimes natural light can be enough!

### Think Green

- Purchase energy-efficient electrical products and appliances. Manufacturers and retailers are legally required to provide consumers with information about the energy efficiency of certain products which will help with decision-making.
- Turn off and plug out items when you are not using them.
- The Sustainable Energy Authority of Ireland, SEAI.ie, offers practical energy-saving tips.



### Pre-Ducted For Car Charging

#### Electric vehicles

Your house is pre-ducted with a charging point that is situated at the front door or gable. For wiring to the house, you will need to ensure that it's connected to the charging port. Charging at home means greener driving and it is a huge advantage to have a charging point already pre-ducted at home as sales of electric vehicles continue to rise.

#### On the move

Your Glenveagh home is centrally located, with easy access to all essential amenities. Be they retail outlets, hospitals, or schools, everything is at a convenient distance. Getting to know the local transport links from walkways to buses to trains should also be a priority when moving into an area for the first time.

#### Biodiversity

At Glenveagh we are committed to protecting biodiversity. Within our developments, as well as providing open spaces for playing areas, you will also find areas that are dedicated to enhancing biodiversity. This includes areas where we allow the grass to grow long rather than mowing it on a regular basis. While sometimes, this can appear a little wild in comparison to the neat gardens we are used to, it has significant benefits for wildlife including pollinators, which are vital for all of us.



## KNOW YOUR AREA

Get to know the best coffee spots, schools, gyms and more in your new Glenveagh community.



## LOCATION

### Connected living near Citywest, Dublin

Foxwood Barn is a superb new development of spacious homes located in the vibrant and well-connected community of Citywest. Foxwood Barn perfectly combines modern, stylish living in a location with a long-celebrated sense of community.

Citywest is a thriving hub for many employers, including Pfizer, Sanofi, SAP and Unilever, allowing many residents to achieve the desirable work/life balance with speedy work commutes.

Explore the best of nature in all seasons with weekend strolls around the local parks, indulge in some retail therapy at the shopping outlets, or catch up with friends at one of the many bustling cafés in the community. Citywest has also evolved as a great location for families, with well-established supermarkets, great schools, and local sports all in the neighbourhood. That's what makes Foxwood Barn an exceptional place for anyone looking to put down roots.





# TRANSPORT

## Everything is within your reach

Foxwood Barn's accessible location means that every amenity is within easy walking distance.

The tranquil surroundings and second-to-none transport links of Citywest make for a popular and ideal spot to put down roots. Foxwood Barn is located mere minutes away from the main N7 road which links Dublin City Centre and Limerick via Naas. Alternatively, the M50 is just a few minute's drive away, opening up all the main routes from Dublin to the rest of Ireland.

For commuters and students looking for more localised travel, Foxwood Barn is only a short walk from the Luas Red Line as well as the 175, 65B, and 77A bus routes, offering fast, frequent and reliable public transport into the city centre. What's more, a relatively short spin on the N81 will bring you to the idyllic Blessington lakes of Wicklow, with its historic greenway, drenched in beauty and surrounded by breathtaking mountains. Need to go even further afield? Dublin Airport is a mere 25 minutes up the road!



### Car Distances

N7	3 Minutes
N81	5 Minutes
M50	7 Minutes
Citywest Shopping Centre	3 Minutes
Citywest Golf Club	6 Minutes
Dublin Airport	25 Minutes
Dublin City Centre	40 Minutes



### Nearby Rail Routes

Luas Red Line Citywest Stop	3 Minutes
Citywest to Stephens Green	1hr 20 mins



### Nearby Bus Routes

- 175 UCD - Citywest
- 65B Poolbeg Street - Citywest
- 77A Ringsend Road - Citywest

## KNOW YOUR AREA



# AMENITIES

## Enjoy so many amenities within walking distance

For those who enjoy living life to the fullest, without a doubt, Foxwood Barn is the place to be. As well as its proximity to Dublin City Centre and the hustle and bustle of a thriving area, Foxwood Barn offers quick access to extensive amenities, from shopping to dining out and from sports to social activities for all ages.

Foxwood Barn is minutes from the Citywest Shopping Centre, which offers extensive shopping and leisure options for you. Home to over 30 stores including Dunnes Stores and Specsavers, Citywest Shopping Centre has an abundance of restaurant and café options to satisfy any taste. For the energetic, excellent sports clubs are abundant such as St.Mary's GAA Club, Shamrock Rovers F.C., Citywest Hotel Golf Club, Newlands Golf Club, or Grange Castle Golf Club, all just a short drive from Foxwood Barn.

## KNOW YOUR AREA

# EDUCATION

### Learn and grow without bounds.

Citywest and the surrounding area offer plenty by way of education, with schools available for children of all ages close to Foxwood Barn.

For younger members of the family, there's Kidorama Creche & Montessori, Stepping Stones Creche and Ard Mor Montessori. Rathcoole ETNS, Scoil Aoife, Citywest & Saggart Community N.S., Citywest Educate Together, Citywest Educate Together, St. Aidan's Senior N.S., St. Mary's N.S. Saggart, and Scoil Chaitlín Maude are situated close to Citywest Village, while Coláiste Pobail Fóla, St. Aidan's Community School, Killinarden Community School, Mount Seskin Community School, and St. Thomas Senior National School are great options for the teens. There are a range of school types in the area too, including Gaelscoileanna and Educate Together options. Third-level education within the local area includes the Technological University of Dublin – Tallaght Campus.

#### PRIMARY SCHOOL

##### Rathcoole ETNS

Fortunestown Lane, Saggart, Dublin 24,  
D24 PFV5

☎ 085 1397152

🌐 [www.rathcooleetns.ie](http://www.rathcooleetns.ie)

#### PRIMARY SCHOOL

##### Scoil Aoife, Citywest

Citywest Dr, Citywest, Dublin

☎ (01) 421 5104

🌐 [www.scoilaoifecns.ie](http://www.scoilaoifecns.ie)

#### PRIMARY SCHOOL

##### Citywest & Saggart Community N.S

Fortunestown Lane, Citywest, Dublin 24

☎ (01) 413 3080

🌐 [www.cscns.ie](http://www.cscns.ie)

#### PRIMARY SCHOOL

##### Citywest Educate Together

Citywest Dr, Citywest, Co. Dublin

☎ (01) 412 4060

🌐 [www.citywestetns.ie](http://www.citywestetns.ie)

#### PRIMARY SCHOOL

##### St. Aidan's Senior N.S.

Brookview Ave, Brookfield, Dublin 24

☎ (01) 452 4677

🌐 [www.sacs.ie](http://www.sacs.ie)

#### PRIMARY SCHOOL

##### St. Mary's N.S. Saggart

Lána Gairtéir, Teach Sagard,

☎ (01) 458 9020

🌐 [www.gaelscoil.org](http://www.gaelscoil.org)

#### PRIMARY SCHOOL

##### Scoil Chaitlín Maude

Hazelgrove, Kiltalown, Dublin 24, D24 RYW1

☎ (01) 452 0345

🌐 [www.scoilcm.ie](http://www.scoilcm.ie)

#### SECONDARY SCHOOL

##### Coláiste Pobail Fóla

Heritage Village, Fóla Community College,  
Block B, Garter Ln, Saggart, Co. D24HFC2

☎ (01) 255 1770

🌐 [www.cpfola.ie](http://www.cpfola.ie)

#### SECONDARY SCHOOL

##### St. Aidan's Community School

Brookview Ave, Brookfield, Dublin 24

☎ (01) 452 4677

🌐 [www.sacs.ie](http://www.sacs.ie)

#### SECONDARY SCHOOL

##### Killinarden Community School

Killinarden, Tallaght, Dublin

☎ (01) 452 7447

🌐 [www.killinardencs.ie](http://www.killinardencs.ie)

#### SECONDARY SCHOOL

##### Mount Seskin Community School

Gibbons, Dublin, D24 K033

☎ (01) 452 5788

🌐 [www.mountseskincc.ie](http://www.mountseskincc.ie)

#### SECONDARY SCHOOL

##### St. Thomas Senior National School

Fortunestown Rd, Tallaght, Dublin 24

☎ (01) 452 6555

🌐 [www.stthomas.ie](http://www.stthomas.ie)

#### THIRD LEVEL EDUCATION

##### Technological University of Dublin Tallaght Campus

Blessington Rd, Tallaght, Dublin 24, D24 FKT9

☎ (01) 220 8201

🌐 [www.tudublin.ie/explore/our-campuses/tallaght/](http://www.tudublin.ie/explore/our-campuses/tallaght/)



# HEALTHCARE

## High quality healthcare at your doorstep

Citywest is home to many clinics and specialised medical practices that are well within the vicinity of Foxwood Barn. So, if you're feeling slightly under the weather or there's a family emergency, it's reassuring to know that you'll be in good hands nearby.



### Primacare

Citywest Medical Centre, Citywest Shopping Centre, Fortunestown Lane, Saggart, County Dublin.

☎ (01) 469 3630

🌐 [www.primacare.ie](http://www.primacare.ie)



### Citywest Medical & Dental Centre

Citywest Shopping Centre, Fortunestown Lane, Citywest, Dublin, County Dublin, DUBLIN 24

☎ (01) 469 3630



### Swiftbrook Medical Centre

TLC Centre, Fortunestown Lane, Citywest, Dublin, County Dublin, Dublin 24

☎ (01) 458 5701



### Citywest Medical Centric Health

Unit 5, Citywest Shopping Centre, Citywest, Dublin 24 D24KOYT

☎ (01) 4693630



### Tallaght University Hospital

Tallaght, Dublin 24, D24 NR0A

☎ (01) 414 2000





## ESSENTIALS

**Live, thrive, and shop for your favorites.**

When it comes to shopping for life's essentials, everything and more is available right at your fingertips.

### Post Office

Citywest Shopping Centre, Fortunes Walk, Fortunestown, Dublin 24, D24 RX07

☎ 1850 575 859

### McCabes Pharmacy Citywest

Citywest Shopping Centre, 6-8, Citywest, Dublin

☎ (01) 466 0094

### Newlands Home & Garden Centre

New Rd, Brideswell Commons, Dublin 22, D22 PK06

☎ (01) 459 2013

### Citywest Shopping Centre

Citywest Rd, Citywest, Dublin

☎ (01) 410 5642

### The Square

Belgard Square E, Tallaght, Dublin, D24 ND77

☎ (01) 452 5944

### Avoca Rathcoole

R120, Rathcoole, Dublin

☎ (01) 257 1800

### ALDI

Tallaght, Cross West, Dublin, D24 FEA4

☎ 1800 991 828

### House of Colour Citywest

Unit 26a/27, Citywest Shopping Centre, Citywest Rd, Citywest, Dublin

☎ (01) 410 5860

### Woodies Tallaght

The Square Belgard Road, Tallaght

☎ (01) 427 5390

### Cosgrove Butchers

Unit 11, Citywest Shopping Centre, Citywest Rd, Citywest, Co. Dublin

☎ (090) 647 3099

### Crystalwave Dry Cleaners

Unit 15, Citywest Shopping Centre, Citywest Rd, Dublin

☎ (01) 479 6862

### The Physical Therapy & Sports Injury Clinic

2nd Floor, Citywest Leisure Centre, Garters Lane

☎ 087 969 7825

# SOCIAL

## Treat yourself to a symphony of flavours.

Whatever you're in the mood for - from an appetising gourmet meal, to a fancy frothy coffee or a comforting cuppa, Foxwood Barn is close to any number of restaurants and eateries that will satisfy every taste and occasion.



### McGettigans Cookhouse

Old Naas Rd, Citywest, Dublin  
☎ (01) 461 9966



### Lemongrass Fusion

CityArk Aparthotel, Garter Ln,  
Collegeland, Saggart, Dublin  
☎ (01) 458 8193



### The Woodlock Brasserie

Citywest hotel, Lána Gairtéir,  
Saggart, Dublin, D24 KF8A  
☎ (01) 401 0919



### The Anvil

Bóthar an Teampaill, Saggart, Dublin  
☎ (01) 458 6794



### The Maple Tree

Slade Castle Court, Saggart, Dublin  
☎ (01) 458 0477



### Bel Cibo Citywest

10 Riverwalk, Citywest Business Campus, Dublin  
☎ (01) 479 6015



### Lean Bean

Unit 3, 8 Riverwalk, Citywest Business Campus,  
Dublin 24  
☎ (01) 4796620



### Costa Coffee

Citywest Shopping Centre, Citywest Rd,  
Citywest, Dublin  
☎ (01) 410 5666



### Baked Citywest

Unit 14, Citywest Shopping Centre, Citywest Rd,  
Citywest, Dublin  
☎ (01) 444 3514

# LIVE FOR BEING ACTIVE

## A hotspot for any fitness enthusiast.

Citywest Village's impressive range of sports clubs and recreational facilities is guaranteed to leave any fitness enthusiast spoilt for choice.



### St. Mary's GAA

Pairc Mhuire, Saggart  
☎ (01) 458 9099  
🌐 [www.stmarysgaasaggarrathcoole.gaa.ie](http://www.stmarysgaasaggarrathcoole.gaa.ie)



### Citywest Hotel Golf Club

Garter Ln, Collegeland, Saggart,  
Co. Dublin, D24 KF8A  
☎ (01) 401 0500



### Grange Castle Golf Club

New Nangor Road, Clondalkin,  
Co. Dublin, D22 WY66  
☎ (01) 464 1043  
🌐 [www.grangecastlelegc.com](http://www.grangecastlelegc.com)



### Shamrock Rovers F.C.

Tallaght Stadium, Whitestown Way,  
Tallaght, Dublin 24, D24 FNK6  
☎ (01) 420 3033



### Newlands Golf Club

Newlands Cross, Dublin 22, D22 R867  
☎ (01) 459 3157  
🌐 [www.newlandsgolfclub.com](http://www.newlandsgolfclub.com)



### Énergie Fitness Citywest

Unit 1a, Citywest Shopping Centre,  
Citywest Rd, Citywest, Co. Dublin  
☎ (01) 907 3065  
🌐 [www.energiefitness.com](http://www.energiefitness.com)



### St Mary's Boxing Club

St. Dominic's Road, Tallaght, Dublin  
☎ 089 985 4672



# OUR COMMUNITY

At Glenveagh, we believe in giving back. We enhance the lives of our customers and the environment that surrounds them as part of our Building Lasting Communities Promise. That's why we have invested extensively in significant causes that align with our mission and values. Here are some of the initiatives we are currently involved in:



## Education

We invest in education in our communities in a variety of ways, partnering with local schools to understand their needs and build lasting relationships that benefit children and young people. As well as working with primary and secondary schools around their biodiversity needs, we offer work placements to second and third level students, providing mentorship and valuable work experience.



## Charity

Our main charity partners are ALONE and Jack and Jill Foundation. ALONE caters to the elderly, providing them with a much needed support system. The Jack and Jill Foundation renders in-home nursing care for sick children, and respite support for their families.



## Sustainability

We work closely with our partners to create developments that promote biodiversity. As a part of this, we ensure that there is active community engagement, and that our ecosystems are well-maintained.



## Health and Wellbeing

We support health and wellbeing initiatives that are central to our wider community programmes. Throughout the country, we have worked with a range of outreach programmes at a local level to help promote wellness within our communities and protect the most vulnerable in our society. Providing this relief, for both mental and physical health initiatives, is a core part of our development plans.

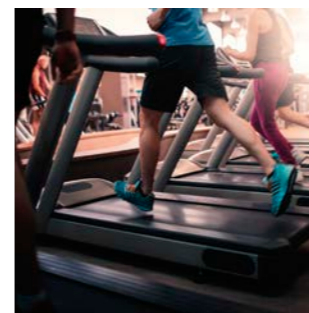

## Sports and Fitness

Glenveagh's ethos is based on building holistic communities where people enjoy playing, working and living. Hence, we believe it is vital for us to aid local sports and fitness initiatives. We are proud to sponsor local teams across local communities. Glenveagh also provides recreational areas, green spaces, playgrounds and cycle tracks for residents, to charitable supports that make a difference in our wider communities.



## Local economy

In association with both local authorities and Chambers of Commerce, we make it a point to engage with local businesses to take on-board all aspects of infrastructure provision and social needs. In line with this, we regularly sponsor local events that foster a rich community spirit.



Discover our full range of  
developments at:

**[glenveagh.ie](http://glenveagh.ie)**

